

MAG Spot 3

Fixture Guide

MAGNETO Track System | Indoor | Surface | Output up to 305lm/module

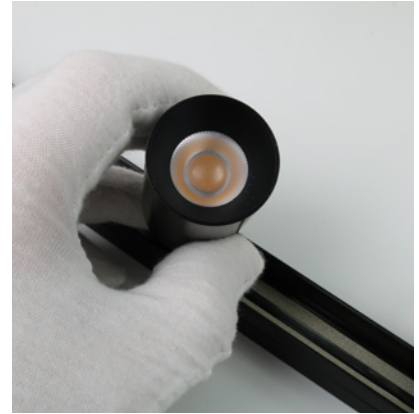

Key applications

- ✓ Cabinet & furniture
- ✓ Ceiling
- ✓ Direct lighting
- ✓ Display case
- ✓ Interior
- ✓ Retail display
- ✓ Shelving display

Key features

- ✓ Adjustable
- ✓ Constant Voltage (CV)
- ✓ Diffusion: spotting
- ✓ Glare control options
- ✓ High lumen efficacy
- ✓ IP40 dry area
- ✓ Lens options

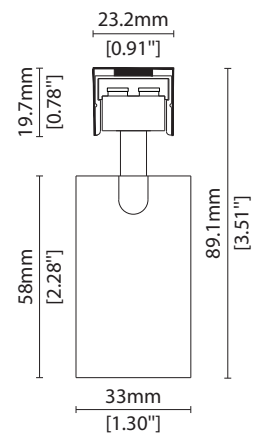

MOUNTING METHOD – MAGNETO Track System

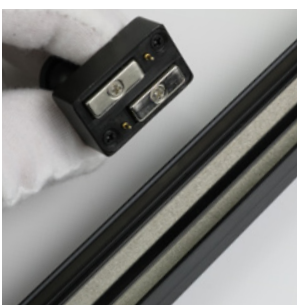

Magnetic track attachment



KKCK-02 MAGNETO Track Clip

MAG Spot 3

Specification sheet



h-
24V DC
5W
≤ 61.0 lm/W
IP40
L70 B10 > 50000h
CE
III
LM79 Tested
LM80 Tested
TM-30 Results

Dimensions	H87.5/Ø33 (H3.44/Ø1.3 in)
Chip	h-line
Cover/Optics	20°/30°/40°
CCT	h-line: 2700K/3000K/3500K/4000K/5000K
LED binning	h-line: 3-step MacAdam ellipse
CRI	≥ 90
Lifetime	50,000 hours @ 25°C (50,000 hours @ 77°F)
Operating temp	T _a = -20 to 30°C (T _c max = 50°C) T _a = -4 to 86°F (T _c max = 122°F)
IP Rating	IP40
Finish	Black
Mounting	Magnetic Track/Clip Mounted
Power feed	Hardwire tail 1000mm (39.37in)
Control	0-10V/1-10V/DMX/DALI



Power consumption	Supply voltage	Supply current
5W	24V DC	0.208A

Performance Data (3000K)

h-line	R1	R2	R3	R4	R5	R6	R7	R8	R9	R10	R11	R12	R13	R14	R15
h-line	97.5	98.6	97.7	98.2	97.8	96.4	98.3	98.6	97.8	98.4	95.8	86.2	97.5	97.7	97.8

h-line	20°	30°	40°	CRI	R9	Rf	Rg
h-line	279lm/module 55.8lm/W	293lm/module 58.6lm/W	305lm/module 61lm/W	97.9	97.8	95	101

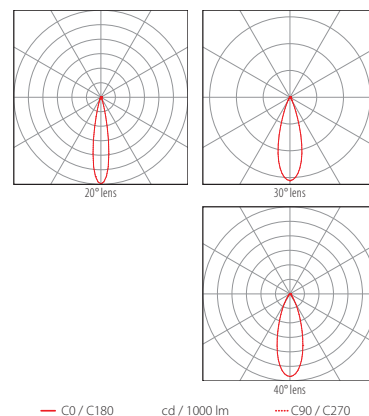
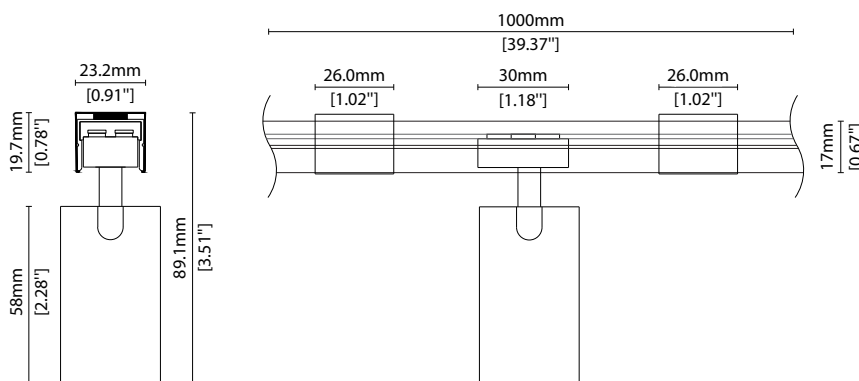

MAG Spot 3

Code Table



FIXTURE

Model	Finish	Cover/Lens	Grade	Colour (CCT)	IP	Cable length	Power feed	Optical	Control	Input
MAG Spot 3	MS3 Black Anodised	BA No cover X	h- h	2700K 27 3000K 30 3500K 35 4000K 40 5000K 50	IP40 40	1000mm 1000 (39.37in)	Single no sheath tail S00X	20° 20 30° 30 40° 40	Switched (ON/OFF) 0	DC 24V g

Code Example:

MS3	-	BA	-	X	-	h-	-	30	-	40	-	1000	-	S00X	-	40	-	0	-	g
MAG Spot 3		Black Anodised		No cover		h-		3000K		IP40		1000mm (39.37in)		Single no sheath tail		40°		Switched (ON/OFF)		DC 24V

ACCESSORIES

Mounting Accessories

KKTR-02-0500	MAGNETO Track Rail 500mm (19.69in)
KKTR-02-1000	MAGNETO Track Rail 1000mm (39.37in)
KKTR-02-1500	MAGNETO Track Rail 1500mm (59.06in)
KKTR-02-2000	MAGNETO Track Rail 2000mm (78.74in)
KKCK-02	MAGNETO Track Rail Fixed Clip bracket
KKCN-36	MAGNETO Track Rail Power Feed

* Refer to **Mounting accessories** on **Accessories** pages

PSU/Driver

0-10V/1-10V/DALI/DMX

* Refer to **Driver/PSU Options** page for details or provide requirement and KKDC to offer the suitable option

LED ENGINE VARIANTS (LED STRIP TYPE)

Luminaire	Lumen/module	W	Spec Doc	Dimension
MAG Spot 1	80.4	1.5	MAG Spot 1	H44/Ø16 (H1.73/Ø0.63 in)
MAG Spot 1-H	52.65	1.5	Mag Spot 1-H	H50.5/Ø16 (H1.99/Ø0.63 in)
MAG Spot 3	305	5	MAG Spot 3	H87.5/Ø33 (H3.44/Ø1.3 in)

* Performance data: h-line, 3000K, 40° lens

LENS OPTIONS

* Options are an integral part of the fixture ordering codes. Please refer to **Code Table** pages.

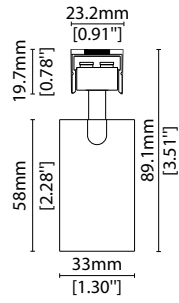

- 20 20° lens
- 30 30° lens
- 40 40° lens

MOUNTING ACCESSORIES

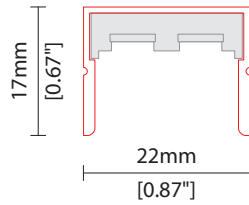
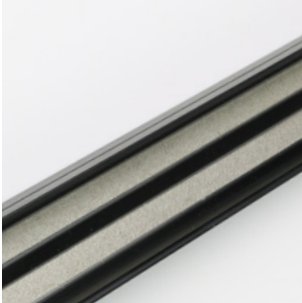

KKTR-02-0500	500mm (19.69in)
KKTR-02-1000	1000mm (39.37in)
KKTR-02-1500	1500mm (59.06in)
KKTR-02-2000	2000mm (78.74in)

MAGNETO Track Rail
Black Anodised finish
W22/H17mm (W0.87/H0.67in)

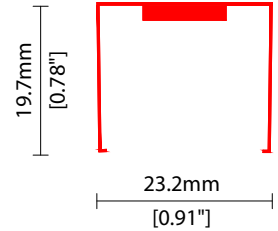
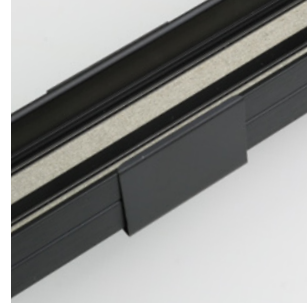

KKCK-02
MAGNETO Track Clip
Black Anodised finish
L26/W23.2/H19.7mm
(L1.02/W0.91/H0.78in)

POWER FEED



KKCN-36

MAGNETO Track power feed
1000mm (39.37in) tail
Black finish

AVAILABLE PSU OPTIONS

Control Mode	PSU (Order Code)	Input Voltage AC	Output Voltage DC	Rated Output Current	Rated Power	Dim %	IP Rating
Switched	CEN-60-24	90-295V	24V	2.5A	60W	-	IP67
	HLG-60H-24	90-305V	24V	2.5A	60W	-	IP67
	HLG-100H-24	90-305V	24V	4.0A	100W	-	IP67
	HLG-150H-24	90-305V	24V	6.3A	150W	-	IP67
	HLG-240H-24	90-305V	24V	10A	240W	-	IP67
0-10V (1-10V)	PWM-40-24	90-305V	24V	1.67A	40W	100-0.15 (100-10)	IP67
	PWM-60-24	90-305V	24V	2.5A	60W	100-0.15 (100-10)	IP67
	PWM-90-24	90-305V	24V	3.67A	90W	100-0.15 (100-10)	IP67
	PWM-120-24	90-305V	24V	5.0A	120W	100-0.15 (100-10)	IP67
DALI	LIN100A1	120-277V	24V	1A per channel	100W	100-0.1	IP66/IP40
DMX RGB	LIN100A1	120-277V	24V	1.33A per channel	100W	100-0.1	IP66/IP40
DMX RGBW	LIN100A1	120-277A	24V	1A per channel	100W	100-0.1	IP66/IP40

Flicker Free Options - Combination of PSU+ sub-controller

Control Mode	PSU (Order Code)	Sub-controller (Order Code)	Input Voltage AC	Output Voltage DC	Rated Output Current	Rated Power	Dim %	IP Rating PSU/ Sub-controller
0-10V or 1-10V	CEN-60-24	KKDM-06	90-295V	24V	2.5A	60W	100-0.9	IP67/IP20
	HLG-60H-24	KKDM-06	90-295V	24V	2.5A	60W	100-0.9	IP67/IP20
	HLG-100H-24	KKDM-06	90-295V	24V	4.0A	100W	100-0.9	IP67/IP20
	HLG-150H-24	KKDM-06	90-295V	24V	6.3A	150W	100-0.9	IP67/IP20
	HLG-240H-24	KKDM-06	90-295V	24V	10.0A	240W	100-0.9	IP67/IP20
DALI	CEN-60-24	KKDL-02/03/04/visDIM PRO 30	90-295V	24V	2.5A	60W	100-0.1	IP67/IP20
	HLG-60H-24	KKDL-02/03/04/visDIM PRO 30	90-305V	24V	2.5A	60W	100-0.1	IP67/IP20
	HLG-100H-24	KKDL-02/03/04/visDIM PRO 30	90-305V	24V	4.0A	100W	100-0.1	IP67/IP20
	HLG-150H-24	KKDL-02/03/04/visDIM PRO 30	90-305V	24V	6.3A	150W	100-0.1	IP67/IP20
	HLG-240H-24	KKDL-02/03/04/visDIM PRO 30	90-305V	24V	10.0A	240W	100-0.1	IP67/IP20
DMX RGB	CEN-60-24	KKSC-05	90-295V	24V	2.5A	60W	100-0.9	IP67/IP20
	HLG-60H-24	KKSC-05	90-305V	24V	2.5A	60W	100-0.9	IP67/IP20
	HLG-100H-24	KKSC-05	90-305V	24V	4A	100W	100-0.9	IP67/IP20
	HLG-150H-24	KKSC-05	90-305V	24V	6.3A	150W	100-0.9	IP67/IP20
	HLG-240H-24	KKSC-05	90-305V	24V	10.0A	240W	100-0.9	IP67/IP20

¹ The items shown above cover the most frequently used specification but does not exhaust the possible options

² PSU and/or driver can be chosen from the table, or KKDC may recommend the best option upon receipt of the controls requirement and installation environment

³ Electrical shop drawing will include detailed information of PSU and relevant control drivers

⁴ Cut sheets are available on the controls section of www.kkdc.lighting or upon request